

USER MANUAL

062.03R SPINNER RED
062.03G SPINNER GREEN

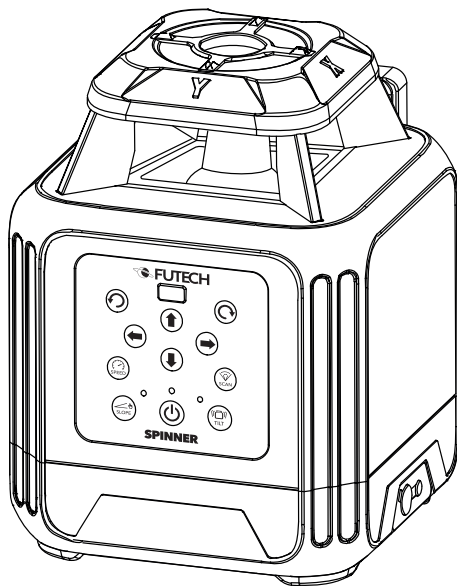

EN ENGLISH

Manual
in your language?

Check the back cover



FUTECH
futech-tools.com

OVERVIEW

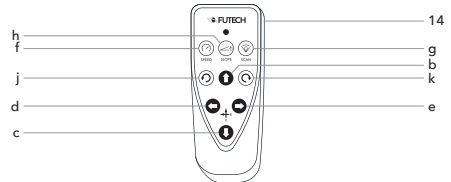
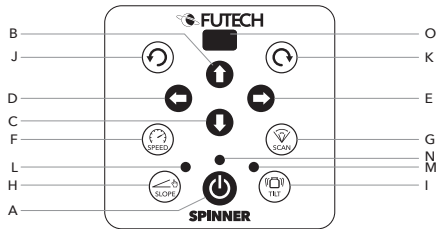
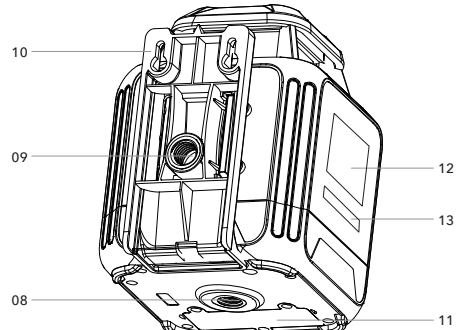
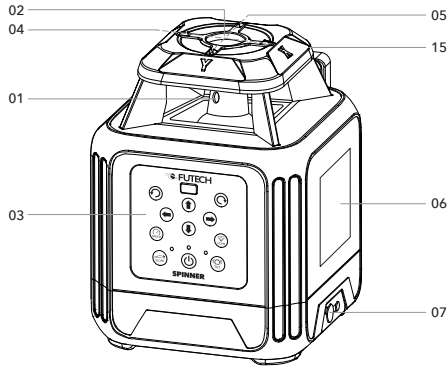

HOUSING

- 01 Laser head
- 02 Plumb point up (Z-axis)
- 03 Keypad
- 04 X-axis
- 05 Y-axis
- 06 Quick guide
- 07 Power socket
- 08 5/8" screw Horizontal mode
/ Plumb point down (Z-axis)
- 09 5/8" screw Vertical mode
- 10 Wallmount
(horizontal mode) /
Foot (vertical mode)
(removable)
- 11 Battery compartment
- 12 Model label
- 13 Serial number
- 14 Remote control
- 15 Window cover

KEYPAD

- A Power button
- B Arrow UP button
- C Arrow DOWN button
- D Arrow LEFT button
- E Arrow RIGHT button
- F Speed button
- G Scan button
- H Slope button
- I Tilt button
- J Turn LEFT button
- K Turn RIGHT button
- L LED Slope indicator
- M LED Tilt indicator
- N LED Power indicator
- O Infrared eye

REMOTE CONTROL

- b Arrow UP button
- c Arrow DOWN button
- d Arrow LEFT button
- e Arrow RIGHT button
- f Speed button
- g Scan button
- h Slope button
- j Turn LEFT button
- k Turn RIGHT button



QUICK START GUIDE

KEYPAD	REMOTE CONTROL	NAME	FUNCTION	
A	-	Power button	Press short	Switch ON/OFF the device
B	b	Arrow UP button	Press short or Hold	Change the slope. Y-axis rises on the side pointed by the arrow of the y-axis.
C	c	Arrow DOWN button	Press short or Hold	Change the slope. Y-axis descends on the side pointed by the arrow of the y-axis.
D	d	Arrow LEFT button	(Horizontal mode) Press short or Hold	Change the slope. X-axis rises on the side pointed by the arrow of the x-axis.
			(Vertical mode) Press short or Hold	Move the laser line and dot (z-axis) to the left
E	e	Arrow RIGHT button	(Horizontal mode) Press short or Hold	Change the slope. X-axis descends on the side pointed by the arrow of the x-axis.
			(Vertical mode) Press short or Hold	Move the laser line and dot (z-axis) to the right
F	f	Speed button	Press short	Change spinning speed 0 - 120 - 300 - 600 RPM
G	g	Scan button	Press short	Use and change scan modus 0° - 10° - 45° - 90° - 180°
H	h	Slope button	Press short	Switch ON slope modus. (Automatic levelling is switched off)
I	-	Tilt button	Press short	Switch ON/OFF Tilt security
J	j	Turn LEFT button	Press short or Hold	Turn the laser anti clockwise in scan modus or when speed is 0 RPM.
K	k	Turn RIGHT button	Press short or Hold	Turn the laser clockwise in scan modus or when speed is 0 RPM.



KEYPAD	REMOTE CONTROL	NAME	FUNCTION	
L	-	LED Slope indicator	No	Slope modus OFF
			Red, continuous	Slope modus ON
			Red, flashing	Laser out of levelling range
M	-	LED Tilt indicator	No	Tilt security OFF
			Red, flashing slow	Preparing TILT security
			Red, continuous	TILT security active
			Red, flashing fast	TILT alarm
N	-	LED Power indicator	Green, continuous	Power ON
			No	Power OFF
O	-	Infrared eye	Receives instructions from the remote control. Always point the remote control to this infrared eye.	



SAFETY

Please read the safety instructions provided as separate booklet with the device.

LASER RADIATION – Class 2 Laser product. – Do not stare into beam

FIRST TIME USAGE

Remove all protection foils.

The li-ion battery is installed by the manufacturer. Make sure the battery is fully charged.

Place 2x AAA Alkaline batteries in the remote control.

BATTERY AND CHARGER

Laser:

This laser works with 2x 7.4V 4000mAh LI-ION rechargeable battery. To charge this battery, you can use the provided charger.

The battery is installed by the manufacturer. In case it needs to be replaced, contact an authorised technician.

Remote control:

The remote control works with 2x 1.5V AAA Alkaline batteries.

AUTOMATIC FUNCTIONS

■ AUTO-LEVELLING

This rotation laser always levels itself automatically after turning on the device. After being levelled, the laser starts spinning. The laser can level itself within an operating angle of approx. 5°. The auto-levelling system performs the necessary fine adjustments, with the help of 3 electronic measuring sensors, one for each axis (X, Y and Z).

— TILT SECURITY

The tilt-security avoids measuring errors. By default, the laser will be active with the tilt-security activated. After turning on the laser or after activating the tilt-security, the tilt-security is prepared during 60 seconds. During this time you can install the laser in the correct position. 60 seconds after you hit the last button, the tilt-security is active.

When the tilt-security sensors detect a small shock (e.g. a vibration, a gust of wind, ...) the laser will stop turning and starts flashing and beeping. This gives you the opportunity to check if the laser is still in the correct position after the shock. You must exit the tilt function, place the laser in position and restart the laser to continue. A new preparation process of approx. 60 seconds will



start before the Tilt-security is active.

Tilt-security is the best choice if accuracy is the most important.

— BASIC MODE (TILT-SECURITY OFF)

In the basic mode the laser will stop spinning if the sensors detect a slight shock, such as a vibration or gust of wind. The laser will re-level and automatically start spinning again when it is levelled again.

This function is a compromise between accuracy and efficiency.

USE

Press the power button [A] to activate the device.

NOTE

The choice of the tripod defines in a large way the user-friendliness of the device.

If the workplace has a high light intensity, for example when working outside in a sunny area, you will need a laser receiver to detect the laser beam.

■ HORIZONTAL ALIGNMENT

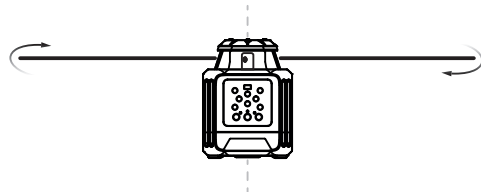

After turning on the device, the laser light blinks without spinning. The laser is levelling. When levelled, the laser beam will light continuously and the laser will start spinning at 600 RPM, the optimal speed for usage with a receiver.

By default, the Tilt security will prepare after turning on the device.

NOTE

The device should not be placed on a surface with a slope of more than 5°. If this is the case, the laser is outside the self-levelling range, in which case the laser diode will continue to blink and the LED slope indicator [L] will flash red.

■ PLUMB LINE

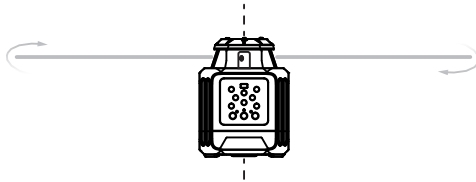

Thanks to the plumb lines, which are projected via Plumb point up [02] and Plumb point down [08], this device can also be used to bring a plumb lead point of the floor to the ceiling, or vice versa.

- Mark the starting point.
- Place the laser beam exactly on this starting point.
- Wait until the laser is levelled.
- Now you can mark the opposite plumb point accordingly.

■ VERTICAL ALIGNMENT

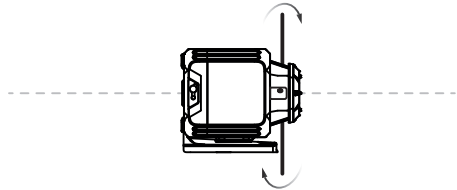

Put the device on its feet vertical mode [10] for vertical alignment (keypad should be on top). The laser will blink without turning during levelling. When levelled, the laser beam will light continuously and the laser will start spinning at 600 rotations per minute, the optimal speed for usage with a receiver.

NOTE

The device should not be placed on a surface with a slope of more than 5°. If this is the case, the laser is outside the levelling range, in which case the laser diode will continue to blink and the LED slope indicator [L] will flash red.



■ ANGLES OF 90°

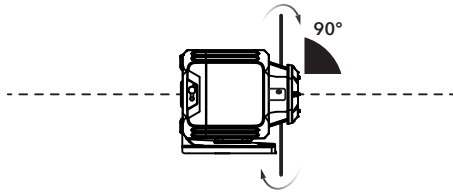

In vertical position, it is possible to project angles of 90°.

- Position the laser head [01] as precise as possible above the starting point, where the corner of 90° is made. It can be helpful to change the spinning speed to zero when positioning the laser above the starting point.
- Bring the rotating laser beam to your first mark. You can use the arrow left button [D, d] and arrow right button [E, e] for fine tuning.
- The Plumb point up [02] (and Plumb point down [08]) show each a corner of 90° with the rotating laser line.

■ SPINNING SPEED

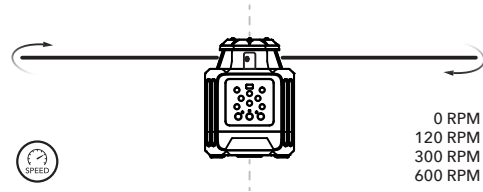

This device has multiple spinning speeds. 0, 120, 300 and 600 RPM (rotations per minute). The default rotation speed is 600 RPM.

- Press the speed button [F, f] to select the desired speed. Each time you press this button, the speed will change.
600 - 0 - 120 - 300 - 600 - 0 - ...
A speed of 0 RPM projects a stationary laser point. This can be positioned exactly at the measuring point with the turn LEFT button [J, c] or turn RIGHT button [K, b] button.

NOTE

The slower the rotational speed, the better the visibility with the human eye. A faster rotation speed is necessary to use a laser receiver (600 RPM recommended for handheld receivers.)

■ SCAN FUNCTION

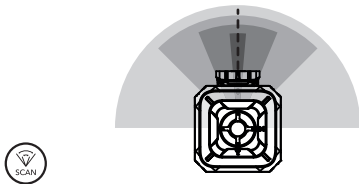

0°
10°
45°
90°
180°

The scan function allows to limit the laser beam to an angle instead of the complete 360° circle. This creates a light intensive segment that increase the visibility for the human eye.

Possible angles of the scan function are 0°, 10°, 45°, 90° and 180°.

- Press the scan button [G, g] to select the desired angle of the scan function. Each time you press this button, the angle will change.
0° - 10° - 45° - 90° - 180° - 0° - 10° - ...

You can move the position of the light intensive segment by pressing the turn LEFT button [J, c] or turn RIGHT button [K, b] button.

■ SLOPE FUNCTION

Standard, the instrument shows a 100% horizontal or vertical laser beam. When needed, the laser can project a sloped laser beam.

To set up slopes, you must take a few steps in the right order.

NOTE

Keep in mind that auto-levelling is disabled when working with the slope function.

— HORIZONTAL SLOPE, <5°

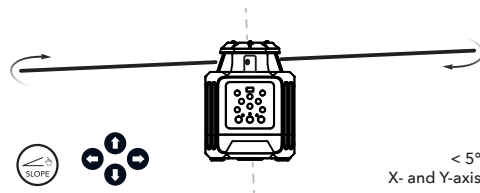

- Place the laser in its horizontal (normal) position.
- Position the x-axis [04] and y-axis [05] of the laser device (shown on the window cover [15]) exactly in the parallel with the direction of the slope(s) you want to make.
- Turn on the device and wait until it is levelled.
- Choose a distance in the direction of the slope that needs to be set up. (e.g. 10m)



- Place the receiver by means of the clamp on a measuring rod and slide the receiver until the laser beam is at the zero level of the receiver.
- Activate the Slope function with the slope button [H]. (LED slope indicator [L] turns red).

We first set the slope over the x-axis

- Position the receiver in line with the x-axis at the desired height on the rod to set the slope over the x-axis. (e.g. 2% slope on 10m = height difference of 20cm up or down)
- Search the zero level of the receiver with the laser beam using the arrow LEFT [D, d] / RIGHT [E, e] button (for a slope on the X-axis).

Now we set the slope over the y-axis.

- Position the receiver in line with the y-axis at the desired height on the rod to set the slope over the y-axis. (e.g. 3% slope on 5m = height difference of 15cm up or down)
- Search the zero level of the receiver with the laser beam using the arrow UP [B, b] or DOWN [C, c] button (for a slope on the Y-axis).

Your laser is set with the desired slope.

— VERTICAL SLOPE, <math>< 5^\circ</math>

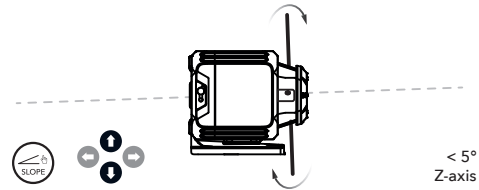

- Place the laser in its vertical position (on the feet vertical mode [10]).
- Turn on the device and wait until it is levelled.
- Activate the Slope function with the slope button [H]. (LED slope indicator [L]).
- Use the arrow UP [B, b] or DOWN [C, c] button to set a slope on the vertical line. (If you want, you can reposition the vertical line using the arrow LEFT [D, d] or RIGHT [E, e] button.)
- Your laser is set with the desired slope.



__ HORIZONTAL SLOPE, $>5^\circ$

Steeper slopes, slopes outside the laser leveling range, can be set using a slope adapter, which is available as optional accessory.

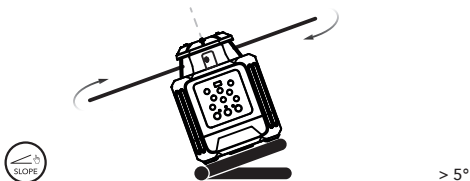



In case you use this slope adapter:

- Place the laser in its horizontal (normal) position on the slope adapter. Make sure the slope adapter is at its 0% position.
- Position the laser in the correct axis-direction, parallel with the slope line you like to make.
- Turn on the device and wait until it is levelled.
- Activate the Slope function with the slope button [H]. (LED slope indicator [L]).
- Set the slope adapter in the desired slope. (Percentage of slope is normally marked on the slope adapter)
- Your laser is set with the desired slope.



SPECIFICATIONS

	062.03R SPINNER RED	062.03G SPINNER GREEN
Visibility		
Precision		1,5mm / 10m
Range (with receiver)		2x ± 250m
Dust- and water resistance		IP55
Levelling		Motorised
Plumb bob		✓
Rotations per minute		0, 120, 300, 600
Scan function		0°, 10°, 45°, 90°, 180°
Wind function		✗
Tilt security		✓
Self-levelling range		± 5°
Slope function		Manually, Electronic
Maximum settable slope (X- and Y-axis)		± 5°
Remote control		✓
Built-in screw (for tripod)		5/8" (horizontal mode) - 5/8" (vertical mode)
AC power connector		✓
Battery		LI-ION, 7.4V; 2x 4000mAh
AC power adapter (charger)		8.4V, 1000mA
Laser	Class 2, 635nm, <1mW max. output (downpoint: Class 2, 650nm, <1mW)	Class 2, 515nm, <1mW max. output (downpoint: Class 2, 650nm, <1mW)
D x W x H device		150 x 128 x 161 mm
Weight (with battery placed)		1,5 kg





DECLARATION OF CONFORMITY

Futech (Belgium) declares under its own responsibility that this device:

- 062.03R, Spinner RED
- 062.03G, Spinner GREEN

is in conformity with the standards

EN 61000-6-3:2007+A1:2011,
EN 61000-6-1:2007,
EN 60825-1:2014,
EN 61010-1:2010,

following the provisions of Directive(s)

2014/30/EU,
2014/35/EU.

Lier, Belgium,
Mars 10, 2023
Patrick Waüters

Potential misprints are reserved. Images used are not strict. All features, functionality and other product specifications are subject to change without notice or obligation.



NOTES



USER MANUAL

other languages:



DA DANSK



DE DEUTSCH



ES ESPAÑOL



ET EESTI KEEL



FI SUOMEN KIELI



FR FRANÇAIS



IS ÍSLENSKA



IT ITALIANO



NL NEDERLANDS



NO NORSK



PT PORTUGUÊS



SL SLOVENŠČINA



SV SVENSKA



Facebook
@futechtools



LinkedIn
futechtools



World Wide Web
futech-tools.com



YouTube
@futechtools