

USER MANUAL

052.01R PARA ONE RED
052.01G PARA ONE GREEN

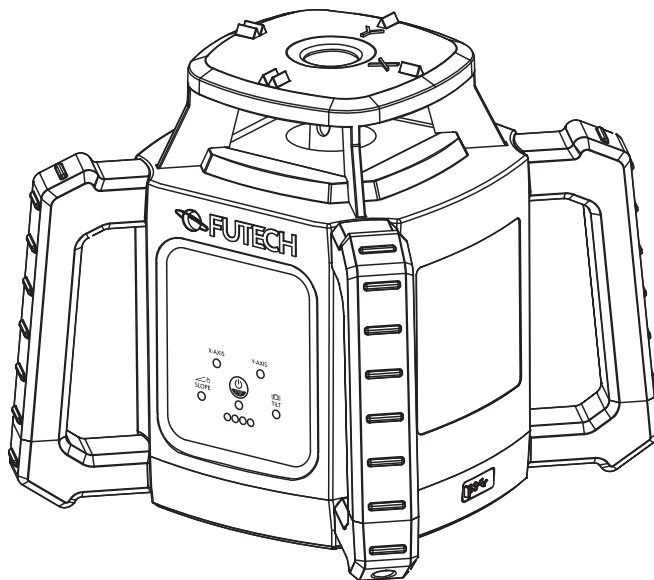

EN ENGLISH

Manual
in your language?

Check the back cover



FUTECH
futech-tools.com

OVERVIEW

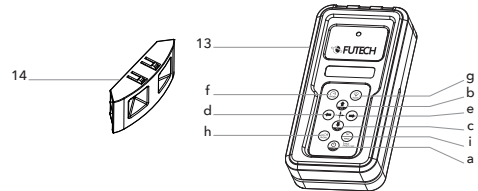
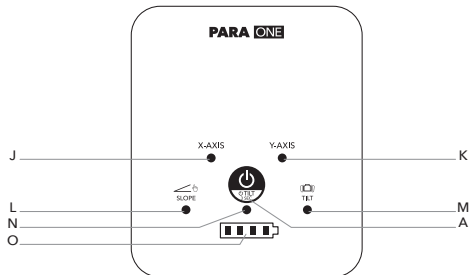
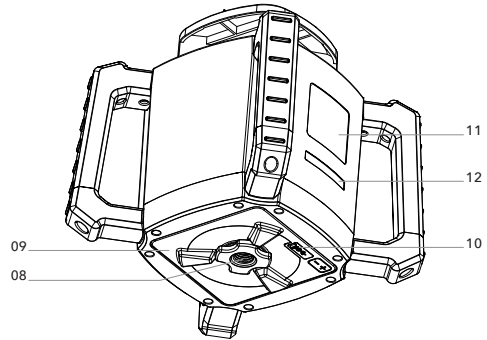
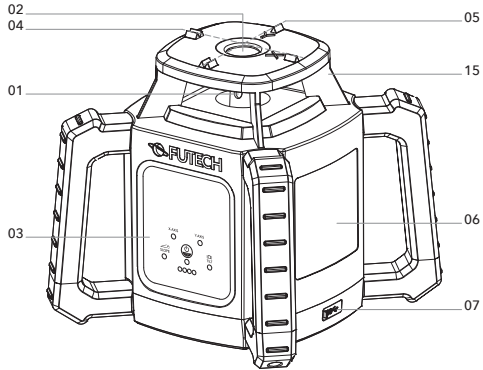

HOUSING

- 01 Laser head
- 02 Plumb point up
- 03 Keypad
- 04 X-axis
- 05 Y-axis
- 06 Quick guide
- 07 USB-C Power socket
- 08 5/8" screw Horizontal mode
- 09 LI-ION battery
- 10 USB-C power socket
(battery)
- 11 Model label
- 12 Serial number
- 13 Remote control
- 14 Anti reflection clip
- 15 Metal window cover

KEYPAD

- A Power button / Tilt
- J LED indicator X-axis
- K LED indicator Y-axis
- L LED Slope indicator
- M LED Tilt indicator
- N LED Power indicator
- O LEDS Battery indicator

REMOTE CONTROL

- a Power / standby button
- b Arrow UP button /
Turn RIGHT button
- c Arrow DOWN button /
Turn LEFT button
- d Arrow LEFT button
- e Arrow RIGHT button
- f Speed button
- g Scan button
- h Slope button
- i Tilt/Wind button



QUICK START GUIDE

KEYPAD	REMOTE CONTROL	NAME	FUNCTION	
A		Power button	Press short	Switch ON/OFF the device
			Hold 3 sec.	(de-)activate TILT security
-	a	Power button	Hold 3 sec.	Set device in standby modus (no laser, no rotation, keep settings)
			b	Arrow UP button / Turn RIGHT button
-	c	Arrow DOWN button / Turn LEFT button		
			-	d
-	e	Arrow RIGHT button		
			-	f
-	g	Scan button		
			-	h
-	i	Tilt/Wind button		
			J	-
Green, continuous	Levelled			
Green, flashing	Levelling in progress			
No	Levelling not active			
			Red, continuous	Levelling not active, a slope was selected.



KEYPAD	REMOTE CONTROL	NAME	FUNCTION	
K	-	LED indicator Y-axis	Green, continuous	Levelled
			Green, flashing	Levelling in progress
			No	Levelling not active
			Red, continuous	Levelling not active, a slope was selected.
L	-	LED Slope indicator	No	Slope modus OFF
			Red, continuous	Slope modus ON
			Red, flashing	Laser out of levelling range
M	-	LED Tilt/Wind indicator	No	Tilt security & Wind modus OFF
			Green, continuous	Wind modus active
			Red, flashing slow	Preparing TILT security
			Red, continuous	TILT security active
			Red, flashing fast	TILT alarm
N	-	LED Power indicator	Green, continuous	Power ON
			No	Power OFF
O	-	LED Battery indicator	4x green	>80% battery charge
			3x green	>60% battery charge
			2x green	>40% battery charge
			1x green	>10% battery charge
			1x red	<10% battery charge

SAFETY

Please read the safety instructions provided as separate booklet with the device.

LASER RADIATION - Class 2 Laser product. - Do not stare into beam

FIRST TIME USAGE

Remove all protection foils.

Place the provided LI-ION battery in the device. Make sure the batteries are fully charged. The four LEDs of the battery indicator light up green.

Place 2x AA Alkaline batteries in the remote control.

BATTERY AND CHARGER

Laser:

This laser works with a 3.7V - 8000mAh LI-ION battery. To charge this battery, you can use the provided 12V - 3A charger for fast charging.

Remote control:

The remote control works with 2x 1.5V AA Alkaline batteries.

AUTOMATIC FUNCTIONS

■ **AUTO-LEVELLING**

This rotation laser always levels itself automatically after turning on the device. After being levelled, the laser starts spinning. The laser can level itself within an operating angle of approx. 5°. The auto-levelling system performs the necessary fine adjustments, with the help of 2 electronic measuring sensors, one for each axis (X and Y).

— **TILT SECURITY**

The tilt-security avoids measuring errors. By default, the laser will be active with the tilt-security activated. After turning on the laser or after activating the tilt-security, the tilt-security is prepared during 60 seconds. During this time you can install the laser in the correct position. 60 seconds after you hit the last button, the tilt-security is active.

When the tilt-security sensors detect a small shock (e.g.: a vibration, a gust of wind, ...) the laser will stop turning and starts flashing and beeping. This give you the opportunity to check if the laser is still in the correct position after the shock. You must exit the tilt function, place the laser in position and restart the laser to continue. A new preparation process of 60 seconds will



start before the Tilt-security is active.

Tilt-security is the best choice if accuracy is the most important.

— BASIC MODE (TILT-SECURITY AND WIND FUNCTION OFF)

In the basic mode the laser will stop spinning if the sensors detect a slight shock, such as a vibration or gust of wind. The laser will re-level and start automatically spinning again when it is levelled again.

This function is a compromise between accuracy and efficiency.

— WIND FUNCTION

The wind function is often used when you need to work on a vibrating surface, or in windy conditions. Also, when quick levelling is needed. The laser doesn't stop spinning when the wind function is active, even if the sensors detect slight shocks. The levelling takes place while the laser is spinning. You can continue to work.

IMPORTANT

Keep in mind that this is the least accurate method of working. Measurement errors can occur.

USE

NOTE

The Para One is a single button device. There are extra functionalities (slope, scan,...) available when using the provided remote control.

Press the power button [A] to activate the device.

NOTE

The choice of the tripod defines in a large way the user-friendliness of the device.

If the workplace has a high light intensity, for example when working outside in a sunny area, you will need a laser receiver to detect the laser beam.

■ HORIZONTAL ALIGNMENT

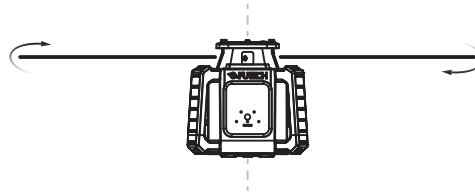

After turning on the device, the laser light blinks without spinning. The LED indicators X-axis [J] and Y-axis [K] blink green during levelling.

When levelled, the laser beam and the LED indicators X-axis [J] and Y-axis [K] will light continuously and the laser will start spinning at 600 rotations per minute, the optimal speed for usage with a receiver.

By default, the Tilt security will prepare after turning on the device.

NOTE

The device should not be placed on a surface with a slope of more than 5°. If this is the case, the laser is outside the self-levelling range, in which case the laser diode will continue to blink and the LED indicator slope [L] will flash red.

■ PLUMB LINE

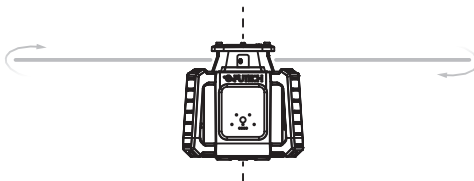

Thanks to the plumb line, which are projected via Plumb point up [02] and Plumb point down [08], this device can also be used to bring a plumb point from the floor to the ceiling, or vice versa.

- Mark the starting point.

- Place the laser beam exactly on this starting point. (We recommend to use a tripod)
- Wait until the laser is levelled.
- Now you can mark the opposite plumb point accordingly.

■ SPINNING SPEED

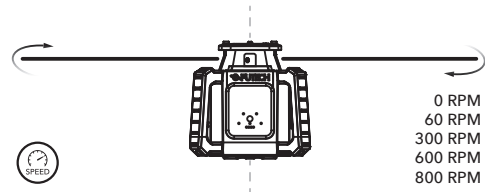

This device has multiple spinning speeds. 0, 60, 300, 600 and 800 RPM (rotations per minute). The default rotation speed is 600 RPM.

- Press the speed button [f] to select the desired speed. Each time you press this button, the speed will change.
600 - 800 - 0 - 60 - 300 - 600 - 800 - ...

A speed of 0 RPM projects a stationary laser point. This can be positioned exactly at the measuring point by holding the arrow UP/turn LEFT button [c] or the arrow down/turn RIGHT button [b] button on the remote control.



NOTE

The slower the rotational speed, the better the visibility with the human eye. A faster rotation speed is necessary to use a laser receiver.

(600 RPM recommended for handheld receivers, 800 RPM recommended for machine receiver)

■ SCAN FUNCTION

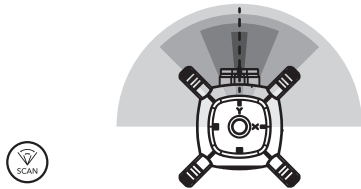

The scan function allows to limit the laser beam to an angle instead of the complete 360° circle. This creates a light intensive segment that increase the visibility for the human eye.

Possible angles of the scan function are 0°, 10°, 45°, 90° and 180°.

- Press the scan button [g] of the remote control to select the desired angle of the scan function. Each time you press this button, the angle will change.

0°
10°
45°
90°
180°

0° - 10° - 45° - 90° - 180° - 0° - 10° - ...

You can move the position of the light intensive segment by holding the arrow up/turn LEFT button [c] or the arrow down/turn RIGHT button [b] button of the remote control.

■ SLOPE FUNCTION

Standard, the instrument shows a 100% horizontal laser beam. When needed, the laser can project a sloped laser beam. To set up slopes, you must take a few steps in the right order.

NOTE

Keep in mind that auto-levelling is disabled when working with the slope function. The LED indicator X-axis [J] and LED indicator Y-axis [K] will switch from green to red to warn you auto-levelling is not active.

— HORIZONTAL SLOPE, <5°

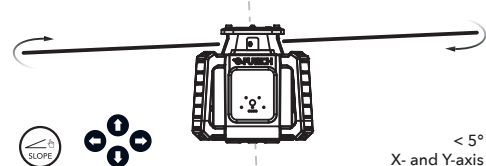

- Place the laser in its horizontal (normal) position.

- Position the x-axis [04] and y-axis [05] of the laser device (shown on the metal window cover [17]) exactly in the parallel with the direction of the slope(s) you want to make.
- Turn on the device and wait until the laser is levelled (LED indicator X-axis [J] and LED indicator Y-axis [K] are solid green).
- Choose a distance in the direction of the slope that needs to be set up. (e.g. 10m)
- Place the receiver by means of the clamp on a measuring rod and slide the receiver until the laser beam is at the zero level of the receiver.
- Activate the Slope function with the slope button [h] of the remote control. (LED slope indicator [L] turns red, LED indicator X-axis [J] and LED indicator Y-axis [K] turns off).

We first set the slope over the x-axis.

- Position the receiver in line with the x-axis at the desired height on the rod to set the slope over the x-axis. (e.g. 2% slope on 10m = height difference of 20cm up or down)
 - Search the zero level of the receiver with the laser beam using the arrow LEFT [d] / RIGHT [e] button of the remote control (for a slope on the X-axis).
- The LED-indicator X-axis [J] turns red once you selected a slope on the X-axis.

Now we set the slope over the y-axis.

- Position the receiver in line with the y-axis at the desired height on the rod to set the slope over the y-axis. (e.g. 3% slope on 5m = height difference of 15cm up or down).
 - Search the zero level of the receiver with the laser beam using the arrow UP [b] or DOWN [c] button of the remote control (for a slope on the Y-axis).
- The LED-indicator Y-axis [K] turns red when you selected a slope on the Y-axis.

Your laser is set with the desired slope.

— HORIZONTAL SLOPE, >5°

Steeper slopes, slopes outside the laser leveling range, can be set using a slope adapter, which is available as an optional accessory.

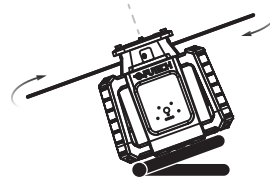

> 5°

In case you use a slope adapter:

- Place the laser in its horizontal (normal) position on the slope adapter. Make sure the slope



adapter is at its 0% position.

- Position the laser in the correct axis-direction, parallel with the slope line you like to make.
- Turn on the device and wait until it is levelled (LED indicator X-axis [J] and LED indicator Y-axis [K] are solid green).
- Activate the Slope function with the slope button [h] of the remote control. (LED slope indicator [L] turns on red, both LED indicators X-axis [J] and Y-axis [K] turn off).
- Set the slope adapter in the desired slope. (Percentage of slope is normally marked on the slope adapter)
- Your laser is set with the desired slope.

■ ANTI-REFLECTION

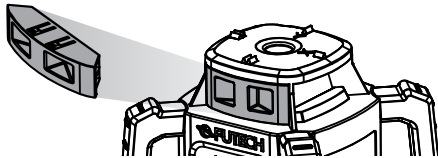



In some cases, unwanted reflections may occur while using a laser, for example when the laser beam shines on glass. This can lead to inaccurate measurement results and affect the proper

functioning of the laser receiver.

It is possible to shield part of the laser beam along the side where the reflection may occur. To do this, use the supplied anti reflection clip [14] by sliding them into the metal window cover [15]. Simply remove this anti reflection clip [16] when covering is no longer needed.

SPECIFICATIONS

	052.01R PARA ONE RED	052.01G PARA ONE GREEN
Visibility		
Precision		1mm / 10m
Range (with receiver)		2x ± 300m
Dust- and water resistance		IP66
Levelling		Motorised
Plumb bob		✓
Rotations per minute		0, 60, 300, 600, 800
Scan function		0°, 10°, 45°, 90°, 180°
Wind function		✓
Tilt security		✓
Self-levelling range		± 5°
Slope function		Manually, Electronic
Maximum settable slope (X- and Y-axis)		± 5°
Remote control		✓
Built-in screw (for tripod)		5/8" (horizontal mode)
AC power connector		USB-C
Battery		LI-ION Battery type: 21700 - 4000 mAh Battery pack: 3.7V - 8000 mAh
AC power adapter (charger)		12V 2A (art.nr.: H052.CHR)
Laser	Class 2, 635nm, <1mW max. output	Class 2, 515nm, <1mW max. output
D x W x H device		220 x 220 x 218 mm
Weight (with battery placed)		2,76 kg





DECLARATION OF CONFORMITY

Futech (Belgium) declares under its own responsibility that this device:

- 052.01R, PARA ONE RED
- 052.01G, PARA ONE GREEN

is in conformity with the standards

EN 61000-6-3:2007+A1:2011,
EN 61000-6-1:2007,
EN 60825-1:2014,
EN 61010-1:2010,

following the provisions of Directive(s)

2014/30/EU,
2014/35/EU.

Lier, Belgium,
Mars 10, 2023
Patrick Waüters

Potential misprints are reserved. Images used are not strict. All features, functionality and other product specifications are subject to change without notice or obligation.



NOTES





USER MANUAL

other languages:



DA DANSK



DE DEUTSCH



ES ESPAÑOL



ET EESTI KEEL



FI SUOMEN KIELI



FR FRANÇAIS



IS ÍSLENSKA



IT ITALIANO



NL NEDERLANDS



NO NORSK



PT PORTUGUÊS



SL SLOVENŠČINA



SV SVENSKA



Facebook
@futechtools



LinkedIn
futechtools



World Wide Web
futech-tools.com



YouTube
@futechtools