



Congratulations!

On choosing this FUTECH instrument. FUTECH provides measuring instruments of precision and quality. Contributions from professional end users enable us to offer innovative, easy-to-use equipment.

MULTICROSS 3 SUPER VISION / MULTICROSS 5 SUPER VISION

Professional cross-line laser with ultra visible laser beams due to the use of powerful laser diodes. Automatic levelling using a pendulum system with magnetic damper, enables greater stability and faster levelling of the pendulum system..

IMPORTANT!

Read the instructions for use carefully before using the instrument. Keep them in a safe place for consultation when necessary.

Whether on or off, keep the instrument out of reach of children.

This equipment is a high quality precision instrument which must be handled with care. Avoid shocks and vibration. After use, always replace the instrument in its carrying bag. Make sure that the bag and instrument are dry; otherwise condensation may occur in the device. Make sure that the windows are free of dirt, and clean them using a soft cloth and a glass cleaning product only. Always use the locking device during transportation. Regularly inspect the accuracy of the instrument, especially when starting any major square-setting work. You have sole responsibility for the accuracy of your work. Do not use any optical equipment such as a magnifying glass to view the laser beam, and take care to remove all reflecting objects to avoid damage to the eye. Locate the laser in such a way that it is not possible for any person to look at the laser beam (intentionally or otherwise). Under no circumstances take the instrument apart, since this may expose you to powerful laser radiation. The laser is only to be used for the projection of laser lines. Do not use the instrument in rain or near flammable materials. Technical modification or alterations to the instrument may be carried out without prior notice. The manufacturer's responsibility shall in no case exceed the value of the costs of repair or replacement of the instrument. Respect the environment and do NOT discard the instrument or batteries in household waste. Take them to a recycling centre.

MULTICROSS 3D

MANUAL

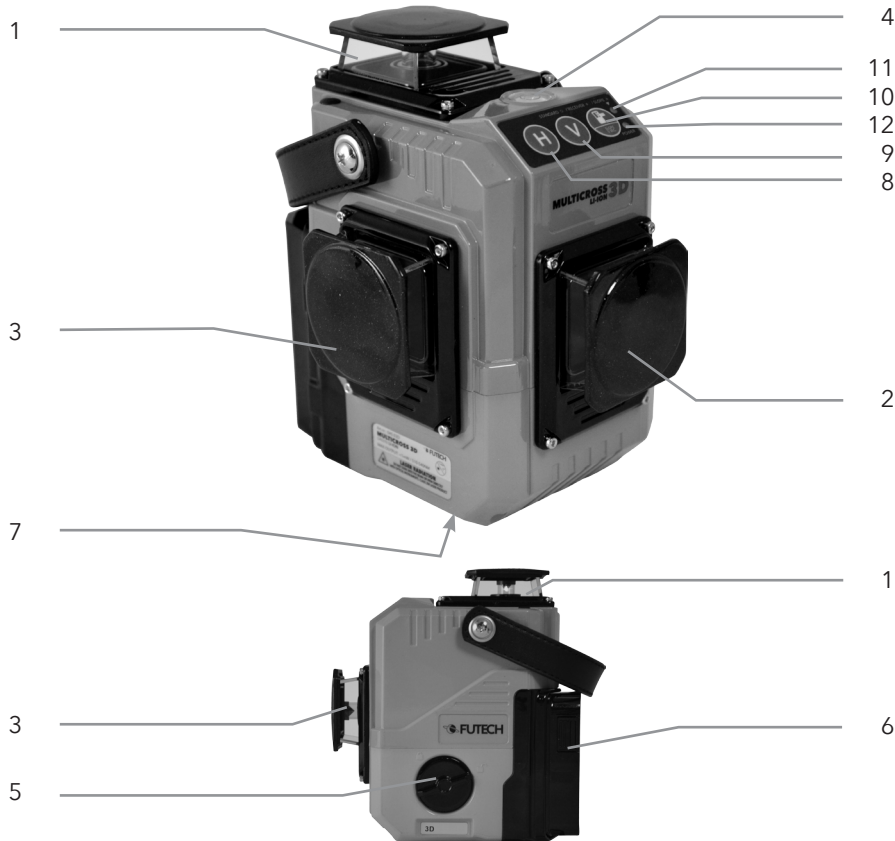

Case

1. Horizontal laserexit
2. Vertical laserexit V1
3. Vertical laserexit V2
4. Level vial
5. On-/Off-button / Pendulumlock
6. LI-ION battery
7. Screw for tripod

Control panel

8. Horizontal laserlines
9. Vertical laserlines
10. Receivermode/slope function
11. Functionindicator
12. Power LED

First use

Remove any protective films where applied and place the rechargeable LI-ION battery. Turn the transportation lock (3) to the "ON" position. The pendulum levelling mechanism is released, and the instrument is able to align itself on its own. Make sure that the instrument is not on too much of a slope (within 3°). If the slope of the instrument should exceed 3°, the lasers will flash or will go out automatically.

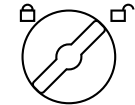
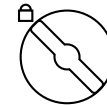
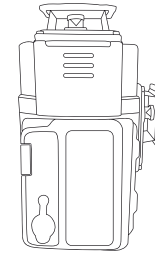

Horizontal and vertical alignment

After disengagement of the pendulum locking system, and provided the instrument is within its levelling range, the laser is levelled. The last used laserlines are active. You can activate or deactivate the horizontal lines using the "H"-button (10) and the "V"-button for the vertical lines. When there are no laserlines activated, the level vial will light.

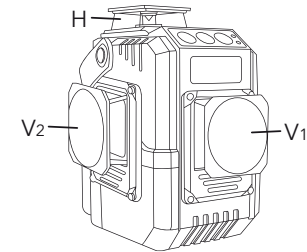

It is advisable to place the horizontal line on your working height.

Attention:

- Cross line lasers can only be used on tripods which are adjustable in height, such as cranked or telescopic tripods.
- If the workplace is very brightly lit, e.g. out of doors, it may be necessary to use the laser receiver.

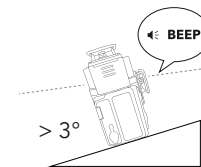

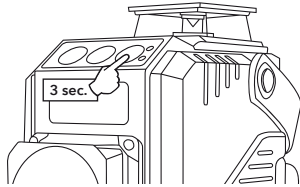
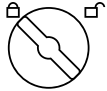

Slope

Turn the On-/Off-button / Pendulumlock (5) to the "LOCK" position. The laser is switched Off and the pendulum is locked.

To activate the slope function, push for 5 seconds the button receiver/slope (10). The last active laserlines will be activated.

You can activate or deactivate the horizontal lines using the "H"-button (10) and the "V"-button for the vertical lines. When there are no laserlines activated, the level vial will light.

IMPORTANT:

- In this mode, the laser lines no longer align automatically. This is signalled by the functionindicator that will blink.

To deactivate the slopefunction, push the button receiver/slope (10) again for a few seconds.

Receivermode

The laser can be used with a receiver in normal mode as well in receiver mode. To activate the receiver mode, push the button receiver/slope (10). The functionindicator (11) will light up when receivermode is active in the normal mode.

Attention:

- Receiver not always included. A list of compatible receivers can be found at www.futech-tools.com.

GENERAL

Description

The following directions should enable the person responsible for the product, and the person who actually uses the equipment, to anticipate and avoid operational hazards. The person responsible for the product must ensure that all users understand these directions and adhere to them.

Adverse Use

- Use of the product without instruction.
- Use outside of the intended limits.
- Disabling safety systems.
- Removal of hazard notices.
- Opening the product using tools, for example screw-driver, unless this is specifically permitted for certain functions.
- Modification or conversion of the product.
- Use after misappropriation.
- Use of products with obviously recognizable damages or defects.
- Use with accessories from other manufacturers without the prior explicit approval of FUTECH.
- Inadequate safeguards at the work site, for example when using on or near roads.
- Deliberate dazzling of third parties.
- Controlling of machines, moving ob-

jects or similar monitoring application without additional control and safety installations.

WARNING

Adverse use can lead to injury, malfunction and damage. It is the task of the person responsible for the equipment to inform the user about hazards and how to counteract them. The product is not to be operated until the user has been instructed on how to work with it.

LIMITS OF USE

Environment

Suitable for use in an atmosphere appropriate for permanent human habitation: not suitable for use in aggressive or explosive environments.

DANGER

Local safety authorities and safety experts must be contacted before working in hazardous areas, or in close proximity to electrical installations or similar situations by the person in charge of the product.

RESPONSIBILITIES

Manufacturer of the product

Laseto N.V., Belgium, BE0808.043.652, hereinafter referred to as FUTECH, is responsible for supplying the product, in-

cluding the user manual and original accessories, in a completely safe condition.

Manufacturers of non FUTECH accessories

The manufacturers of non FUTECH accessories for the product are responsible for developing, implementing and communicating safety concepts for their products, and are also responsible for the effectiveness of those safety concepts in combination with the FUTECH product.

Person in charge of the product

The person in charge of the product has the following duties:

- To understand the safety instructions on the product and the instructions in the user manual.
- To be familiar with local regulations relating to safety and accident prevention.
- To inform FUTECH immediately if the product and the application becomes unsafe.

HAZARDS OF USE

WARNINGS

- The person responsible for the product must ensure that it is used in accordance with the instructions. This person is also accountable for the training and the deployment of personnel who use the product and for the safety of the equipment in use.
- The absence of instruction, or the inadequate imparting of instruction, can lead to incorrect or adverse use, and can give rise to accidents with far-reaching human, material, financial and environmental consequences.
- All users must follow the safety directions given by the manufacturer and the directions of the person responsible for the product.
- Watch out for erroneous measurement results if the product has been dropped or has been misused, modified, stored for long periods or transported.
- Periodically carry out test measurements and perform the field adjustments indicated in the user manual, particularly after the product has been subjected to abnormal use and before and after important measurements.
- If the product is used with accessories, for example masts, staffs, poles, you may increase the risk of being struck by lightning.
- Do not use the product in a thunderstorm.
- Inadequate securing of the working site can lead to dangerous situations, for example in traffic, on building sites, and at industrial installations.
- Always ensure that the working site is adequately secured. Adhere to the regulations governing safety and accident prevention and road traffic.
- If the accessories used with the product are not properly secured and the product is subjected to mechanical shock, for example blows or falling, the product may be damaged or people may sustain injury.
- When setting-up the product, make sure that the accessories are correctly adapted, fitted, secured, and locked in position. Avoid subjecting the product to mechanical stress.
- During the transport, shipping or disposal of batteries it is possible for inappropriate mechanical influences to constitute a fire hazard.
- Before shipping the product or disposing of it, discharge the batteries by running the product until they are flat. When transporting or shipping batteries, the person in charge of the product must ensure that the applicable national and international rules and regulations are observed. Before transportation or shipping contact your local passenger or freight transport company.
- High mechanical stress, high ambient temperatures or immersion into fluids can cause leakage, fire or explosions of the batteries.
- Protect the batteries from mechanical influences and high ambient temperatures. Do not drop or immerse batteries into fluids.
- Short circuited battery terminals can overheat and cause injury or fire, for example by storing or transporting in pockets if battery terminals come in contact with jewellery, keys, metallized paper or other metals.
- Make sure that the battery terminals do not come into contact with metallic objects.
- During the operation of the product there is a hazard of squeezing extremities by moving parts.
- Keep extremities in a safe distance from the moving parts. If the product is improperly disposed of, the following can happen: If polymer parts are burnt, poisonous gases are produced which may impair health. If batteries are damaged or are heated strongly, they can explode and cause poisoning, burning, corrosion

or environmental contamination. By disposing of the product irresponsibly you may enable unauthorized persons to use it in contravention of the regulations, exposing themselves and third parties to the risk of severe injury and rendering the environment liable to contamination.

- The product must not be disposed with household waste. Dispose of the product appropriately in accordance with the national regulations in force in your country.

LASER CLASSIFICATION

General

The following directions (in accordance with the state of the art - international standard IEC 60825-1(2007-03) and IEC TR 60825-14 (2004-02)) provide instruction and training information to the person responsible for the product and the person who actually uses the equipment, to anticipate and avoid operational hazards. The person responsible for the product must ensure that all users understand these directions and adhere to them.

Products classified as laser class 1, class 2 and class 3R do not require:

- laser safety officer involvement,
- protective clothes and eyewear,

- special warning signs in the laser working area if used and operated as defined in this user manual due to the low eye hazard level. Products classified as laser class 2 or class 3R may cause dazzle, flash blindness and afterimages, particularly under low ambient light conditions.

ACCURACY CONTROL

Monitor horizontal levelling

- Choose a room ± 10 m long
- Place the instrument next to wall no. 1.
- Switch on the instrument and let it self-level.
- Mark the horizontal line on wall no 1.
- Mark the horizontal line on wall no 2.
- Move the instrument as close as possible to wall no. 2.
- Adjust the height of the laser so that the middle of the laser cross is on the wall no. 2 marker.
- Then turn the instrument through 180° and note the difference between the middle of the laser cross and the marker on wall no. 1.
- This difference should not exceed the tolerances (See technical specs)

IMPORTANT:

- The tolerance depends on the distance of the walls between which the inspection has been carried out. This distance should be multiplied by 2. Hence, if the instrument has an accuracy of 1 mm / 10 m, then in our example the calculation is: 10 m distance $\times 1 = 10$ m. Tolerance is 2 mm / 20 m.
- *After checking the X-axis repeat the same steps for the Y-axis.*

If your instrument does not reach the required tolerance, it should be returned to your service centre or to your reseller for service. Repairs carried out by unauthorised personnel will automatically invalidate the guarantee.

TECHNICAL SPECIFICATIONS

ACCURACY	± 1,5MM / 10M
RANGE WITH RECEIVER	2X 50M
LEVELLING RANGE	± 2°
LEVELLING	PENDULUM
SLOPE FUNCTION	MANUAL (VIA PENDULUM LOCK)
LASER WAVELENGTH	532NM
LASER CLASSIFICATION	CLASS 2M
POWER SUPPLY	LI-ION BATTERIE
PROTECTION	IP54
DIMENSIONS (L X W X H)	128 X 95 X 140 MM
WEIGHT	0,900 KG
OPERATION TEMPERATURE	0°C ~ +40°C

Notes

.....

.....

.....

.....

.....

.....

.....

.....

.....

.....

.....

.....

.....

.....

.....

.....

.....

.....

.....

.....

.....

.....

.....

Notes

.....

.....

.....

.....

.....

.....

.....

.....

.....

.....

.....

.....

.....

.....

.....

.....

.....

.....

.....

.....

.....

.....

